

描述 / Descriptions

BRCL4054CME是一款完整的单节锂离子电池采用恒定电流/恒定电压线性充电器。其SOT封装与较少的外部元件数目使得BRCL4054CME成为便携式应用的理想选择。BRCL4054CME可以适合USB电源和适配器电源工作。由于采用了内部PMOSFET架构，加上防倒充电路，所以不需要外部检测电阻器和隔离二极管。热反馈可对充电电流进行调节，以便在大功率操作或高环境温度条件下对芯片温度加以限制。充电电压固定于4.2V，而充电电流可通过一个电阻器进行外部设置，当充电电流在达到最终浮充电压之后降至设定值1/10时，BRCL4054CME将自动终止充电循环。BRCL4054CME的其他特点包括充电电流监控器、欠压闭锁、自动再充电和一个用于指示充电结束和输入电压接入的状态引脚。

The BRCL4054CME is a complete constant-current/constant voltage linear charger for single cell lithium-ion batteries. Its Thin SOT package and low external component count make the BRCL4054CME ideally suited for portable applications. Furthermore, the BRCL4054CME is specifically designed to work within USB power specifications.No external sense resistor is needed, and no blocking diode is required due to the internal MOSFET architecture. Thermal feedback regulates the charge current to limit the die temperature during high power operation or high ambient temperature. The charge voltage is fixed at 4.2V, and the charge current can be programmed externally with a single resistor. The BRCL4054CME automatically terminates the charge cycle when the charge current drops to 1/10th the programmed value after the final float voltage is reached.Other features include charge current monitor, under voltage lockout, automatic recharge and a status pin to indicate charge termination and the presence of an input voltage.

特征 / Features

- 高达500mA的可编程充电电流 / Programmable charge current up to 500mA
- 无需MOSFET、检测电阻器或隔离二极管 / No MOSFET, sense resistor or blocking diode required
- 用于单节锂离子电池、采用SOT23-5封装的完整线性充电器 / Complete linear charger in 5-Lead SOT-23 package for single cell lithium-Ion batteries
- 恒定电流/恒定电压操作，并具有热调节功能 / Constant-current/Constant-voltage operation with thermal regulation to maximize charge rate without risk of overheating
- 直接从USB端口给单节锂离子电池充电 / Charges single cell Li-Ion batteries directly from USB port
- 4.2V预设充电电压 / Preset 4.2V charge voltage with $\pm 1\%$ accuracy
- 用于电池电量检测的充电电流监控器输出 / Charge current monitor output for gas gauging
- 自动再充电 / Automatic recharge
- 充电状态输出引脚 / Charge status output pin
- C/10充电终止 / C/10 charge termination
- 2.9V涓流充电 / 2.9V trickle charging
- 软启动限制了浪涌电流 / Soft-start limits Inrush current
- 单灯使用时，充满后灯全灭 / When using a single lamp, the light is completely extinguished after fully charging
- 无卤产品 / Halogen-free product.

用途 / Applications

- 蜂窝电话、PDAs、MP3播放器 / Cellular telephones, PDAs, MP3 players
- 充电座 / Charging docks and cradles
- 蓝牙应用 / Bluetooth applications.

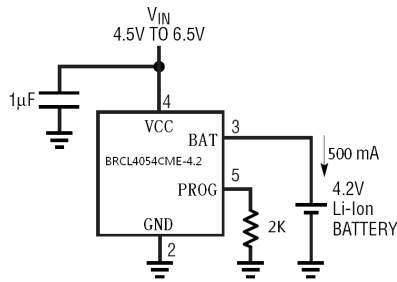
引脚排列及应用电路 / Pinning And Application Circuit

引脚编号 Pin Number	引脚名称 Pin Name	引脚说明 Pin Description
1	CHRG	漏极开路充电状态输出。当充电时，CHRG 端口被一个内置的 N 沟道 MOSFET 置于低电位。当充电完成时，CHRG 呈现高阻态。当检测到低电压锁定条件时，CHRG 呈现高阻态。当在 BAT 引脚和地之间接一 1µF 的电容，就可以完成电池是否接好的指示，当没有电池时，LED 灯会快速闪烁。Open drain charge state output. When charging, the CHRG port is placed at low potential by a built-in N-channel MOSFET. When charging is completed, CHRG presents a high resistance state. When a low voltage locking condition is detected, the CHRG presents a high resistance state. When a 1µ F is connected between bat pin and ground , you can complete the indication of whether the battery is connected. When there is no battery, the LED light will flash quickly.
2	GND	地。Ground.
3	BAT	充电电流输出。该引脚向电池提供充电电流并将最终浮充电压调节至 4.2V，该引脚的一个精准内部电阻分压器设定浮充电压，在停机模式中，该内部电阻分压器断开。Charge Current Output. Provides charge current to the battery and regulates the final float voltage to 4.2V. An internal precision resistor divider from this pin sets the float voltage which is disconnected in shut down mode.
4	VCC	电源脚。VCC的变化范围在4.25V-6.5V之间，并应通过至少一个1µF 电容器进行旁路。当VCC降至BAT引脚电压的30mV以内，进入停机模式，从而IBAT降至2µA以下。Positive Input Supply Voltage. VCC can range from 4.25V to 6.5V and should be bypassed with at least a 1µF capacitor. When VCC drops to within 30mV of the BAT pin voltage, Enter shutdown mode, dropping IBAT to less than 2µA.
5	PROG	充电电流设定引脚。在该引脚与地之间连接一个精度为1%的电阻器 RPRGO可以设定充电电流。当在恒定电流模式下进行充电时，该引脚的电压被维持在1V,在所有的模式中都可以利用该引脚上的电压来测算充电电流，公式为IBAT= (VPROG/RPROG) *1000. Charge Current Program Pin. The charge current is programmed by connecting a 1% resistor, RPROG, to ground. When charging in constant-current mode, this pin serves to 1V. In all modes, the voltage on this pin can be used to measure the charge current using the following formula: IBAT = (VPROG/RPROG)×1000.

印章代码 / Marking

见印章说明。 See Marking Instructions

极限参数 / Absolute Maximum Ratings(Ta=25°C)

参数 Parameter	数值 Rating	单位 Unit
Input Supply Voltage (V _{CC})	-0.3 to 10	V
PROG	-0.3 to V _{CC} + 0.3	V
BAT	-0.3 to 7	V
CHRG	-0.3 to 10	V
BAT Pin Current	500	mA
Operating Ambient Temperature Range	-40~85	°C
Storage Temperature Range	-65~150	°C
Lead Temperature (Soldering,10sec)	300	°C

电性能参数 / Electrical Characteristics(Ta=25°C)

参数 Parameter	符号 Symbol	测试条件 Test Conditions	最小值 Min	典型值 Typ	最大值 Max	单位 Unit
Input Supply Voltage	V _{CC}		4.25		6.5	V
Input Supply Current	I _{CC}	Charge Mode , R _{PROG} =10k		300	2000	μA
		Standby Mode (Charge Terminated)		200	500	μA
		Shutdown Mode (R _{PROG} Not Connected V _{CC} <V _{BAT} , or V _{CC} <V _{UV})		25	50	μA
Regulated Output (Float) Voltage	V _{FLOAT}	0°C≤T _A ≤85°C I _{BAT} =40mA	4.158	4.20	4.242	V
BAT Pin Current	I _{BAT}	R _{PROG} =10k Current Mode	93	100	107	mA
		R _{PROG} =2k Current Mode	465	500	535	mA
		Standby Mode V _{BAT} =4.2V	0	-2.5	-6.0	μA
		Shutdown Mode (R _{PROG} Not Connected)		±1.0	±2.0	μA
		Sleep Mode V _{CC} = 0V		±1.0	±2.0	μA
Trickle Charge Current	I _{TRIKL}	V _{BAT} < V _{TRIKL} R _{PROG} =2k	20	45	70	mA
Trickle Charge Threshold Voltage	V _{TRIKL}	R _{PROG} =10k, V _{BAT} Rising	2.8	2.9	3.0	V
Trickle Charge Hysteresis Voltage	V _{TRHYS}	R _{PROG} = 10k	60	80	110	mV

电性能参数 / Electrical Characteristics(Ta=25°C)

参数 Parameter	符号 Symbol	测试条件 Test Conditions	最小值 Min	典型值 Typ	最大值 Max	单位 Unit
V _{CC} Undervoltage Lockout Threshold	V _{UV}	From V _{CC} Low to High	3.7	3.8	3.92	V
V _{CC} Undervoltage Lockout Hysteresis	V _{UVHYS}		150	200	300	mV
Manual Shutdown Threshold Voltage	V _{MSD}	PROG Pin Rising	1.15	1.21	1.30	V
		PROG Pin Falling	0.9	1.0	1.1	V
V _{CC} - V _{BAT} Lockout Threshold Voltage	V _{ASD}	V _{CC} from Low to High	70	100	140	mV
		V _{CC} from High to Low	5.0	30	50	mV
C/10 Termination Current Threshold	I _{TERM}	R _{PROG} =10k	0.085	0.10	0.115	mA/mA
		R _{PROG} =2k	0.085	0.10	0.115	mA/mA
PROG Pin Voltage	V _{PROG}	R _{PROG} =10k Current Mode	0.93	1.0	1.07	V
CHRG Pin Weak Pull-Down Current	I _{CHRG}	V _{CHRG} =5V	8.0	20	35	μA
CHRG Pin Output Low Voltage	V _{CHRG}	I _{CHRG} = 5mA		0.35	0.60	V
Recharge Battery Threshold Voltage	V _{RECHRG}	V _{FLOAT} -V _{RECHRG}	100	150	200	mV
Junction Temperature in Constant Temperature Mode	T _{LIM}			120		°C
Soft-Start Time	t _{SS}	I _{BAT} =0 to I _{BAT} =1000V/R _{PROG}		100		μs
Recharge Comparator Filter Time	t _{RECHARGE}	V _{BAT} High to Low	0.75	2.0	4.5	ms
Termination Comparator Filter Time	t _{TERM}	I _{BAT} Falling Below I _{CHG} /10	400	1000	2500	μs
PROG Pin Pull-Up Current	I _{PROG}			3.0		μA

原理框图 / Functional Block Diagram

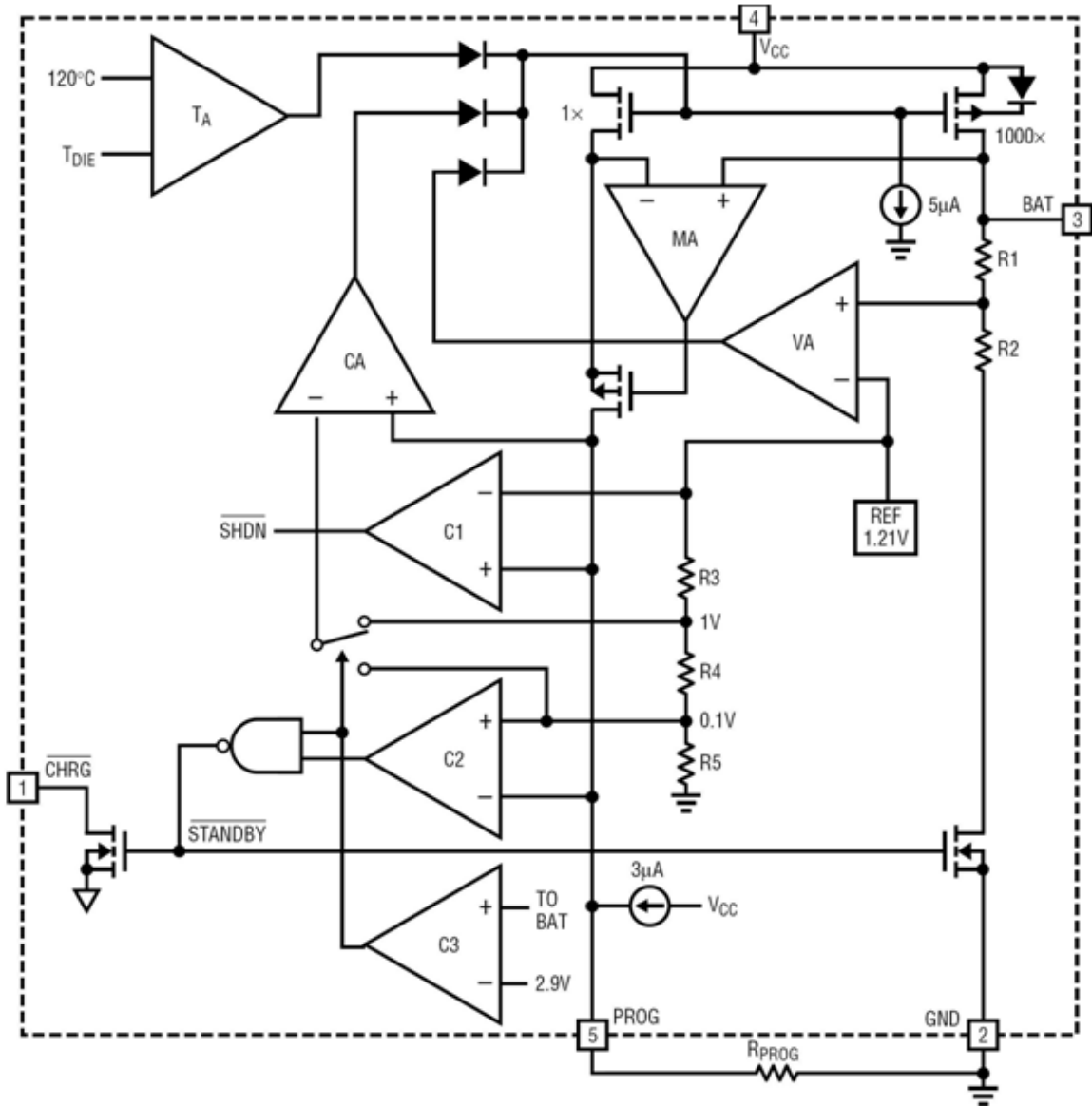

电参数曲线图 / Electrical Characteristic Curve

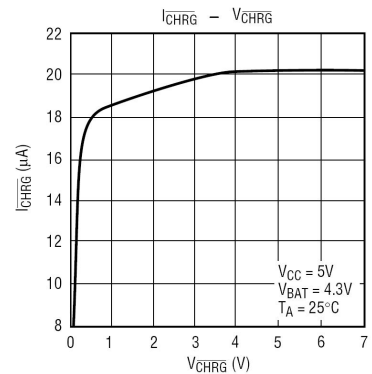
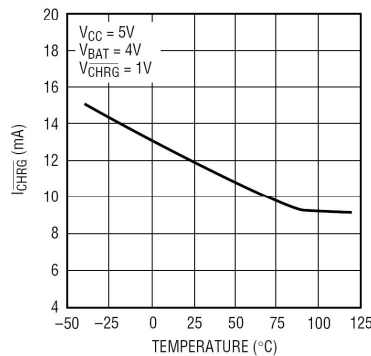
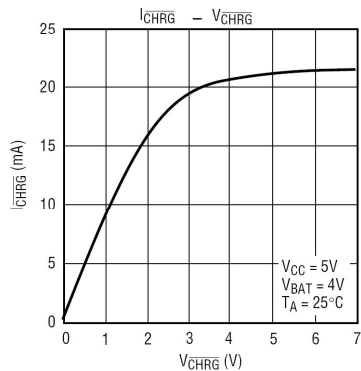
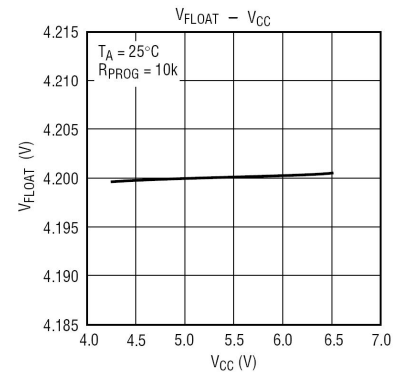
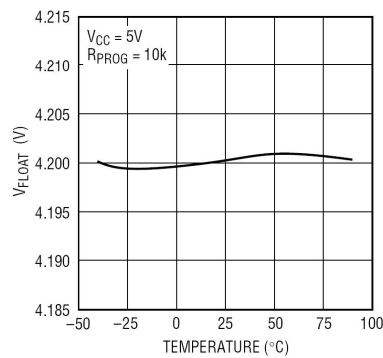
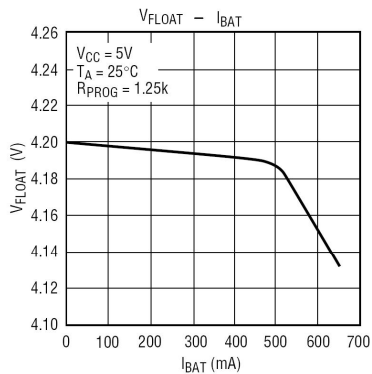
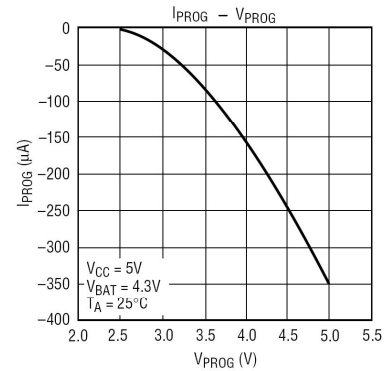
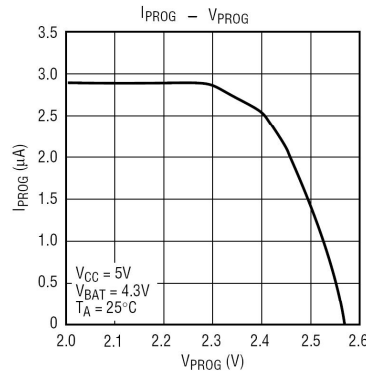
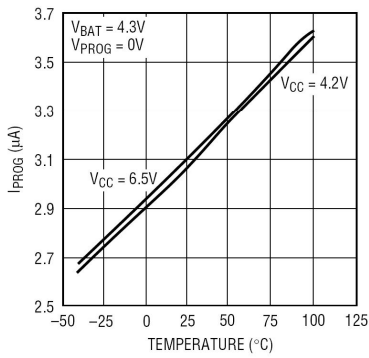
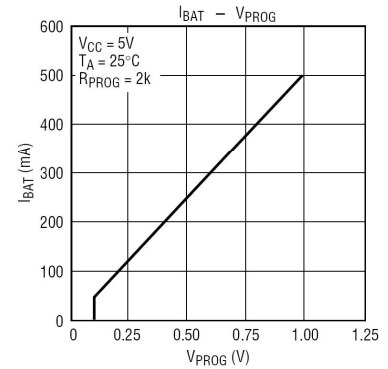
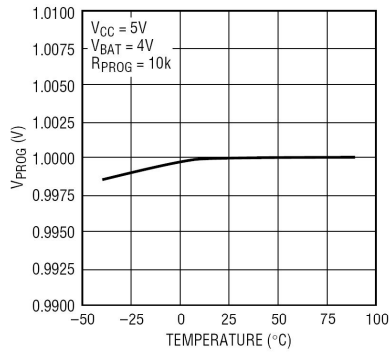
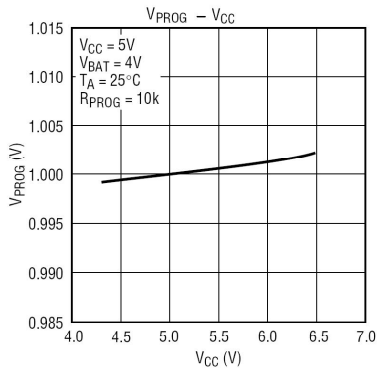

电参数曲线图 / Electrical Characteristic Curve

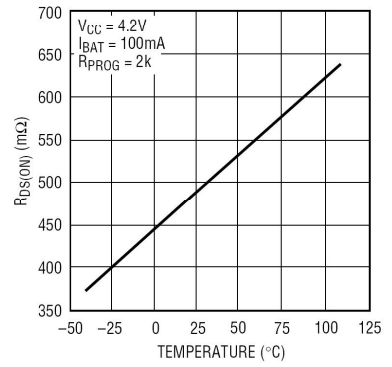
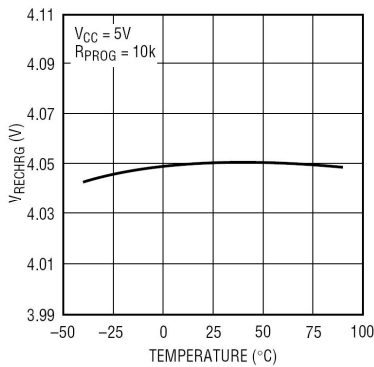
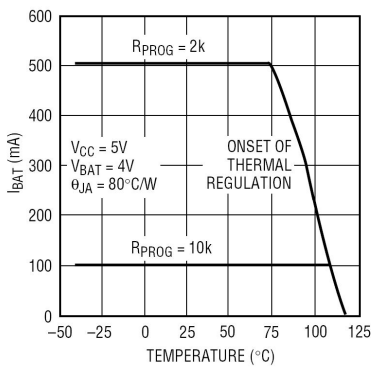
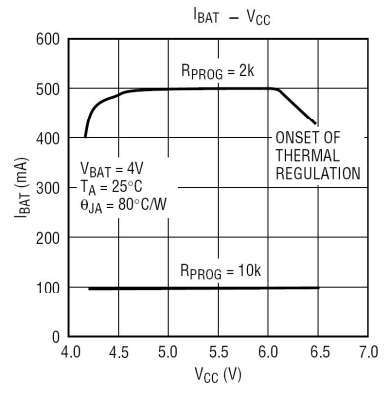
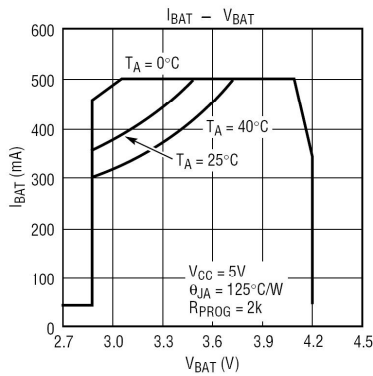
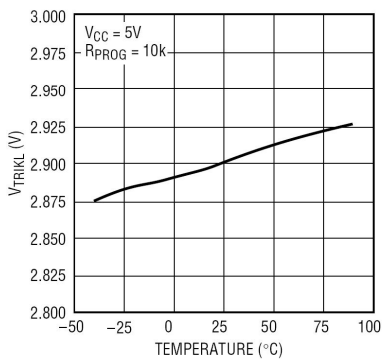
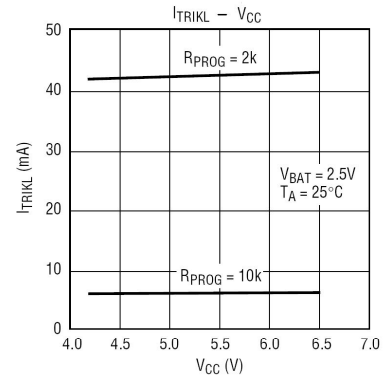
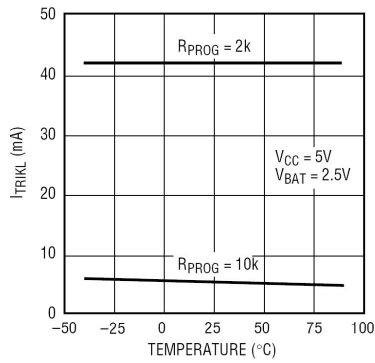
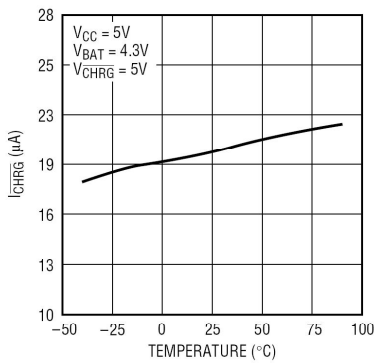

功能描述 / Functional Description

当 V_{CC} 引脚电压升至UVLO门限电平以上且在PROG引脚与地之间连接了一个精度为1%的设定电阻器或当一个电池与充电器输出端相连时，一个充电循环开始。如果BAT引脚电平低于2.9V，则充电器进入涓流充电模式。在该模式中，BRCL4054CME提供约1/10的设定充电电流，以便将电流电压提升至一个安全的电平，从而实现满电流充电。

A charge cycle begins when the voltage at the V_{CC} pin rises above the UVLO threshold level and a 1% program resistor is connected from the PROG pin to ground or when a battery is connected to the charger output. If the BAT pin is less than 2.9V, the charger enters trickle charge mode. In this mode, the BRCL4054CME supplies approximately 1/10 the programmed charge current to bring the battery voltage up to a safe level for full current charging.

当BAT引脚电压升至2.9V以上时，充电器进入恒定电流模式，此时向电池提供恒定的充电电流。当BAT引脚电压达到最终浮充电压（4.2V）时，BRCL4054CME进入恒定电压模式，且充电电流开始减小。当充电电流降至设定值的1/10，充电循环结束。

When the BAT pin voltage rises above 2.9V, the charger enters constant-current mode, where the programmed charge current is supplied to the battery. When the BAT pin approaches the final float voltage (4.2V), the BRCL4054CME enters constant-voltage mode and the charge current begins to decrease. When the charge current drops to 1/10 of the programmed value, the charge cycle ends.

在待机模式中，BRCL4054CME对BAT引脚电压进行连续监控。如果该引脚电压降到4.05V的再充电门限(V_{RECHRG})以下，则另一个充电循环开始并再次向电池供应电流。当在待机模式中进行充电循环的手动再启动时，必须取消然后再施加输入电压，或者必须关断充电器并使用PROG引脚进行再启动。

The BRCL4054CME constantly monitors the BAT pin voltage in standby mode. If this voltage drops below the 4.05V recharge threshold (V_{RECHRG}), another charge cycle begins and current is once again supplied to the battery. To manually restart a charge cycle when in standby mode, the input voltage must be removed and reapplied, or the charger must be shut down and restarted using the PROG pin. 充电电流是采用一个连接在PROG引脚与地之间的电阻器来设定的。电流充电电流是PROG引脚输出电流的1000倍。设定电阻器和充电电流采用下列公式来计算：

The charging current is set by a resistor connected between prog pin and ground. The charging current is 1000 times the output current of prog pin. The setting resistor and charging current are calculated using the following formula :

$$I_{BAT} = \frac{V_{PROG}}{R_{PROG}} \cdot 1000$$

外形尺寸图 / Package Dimensions

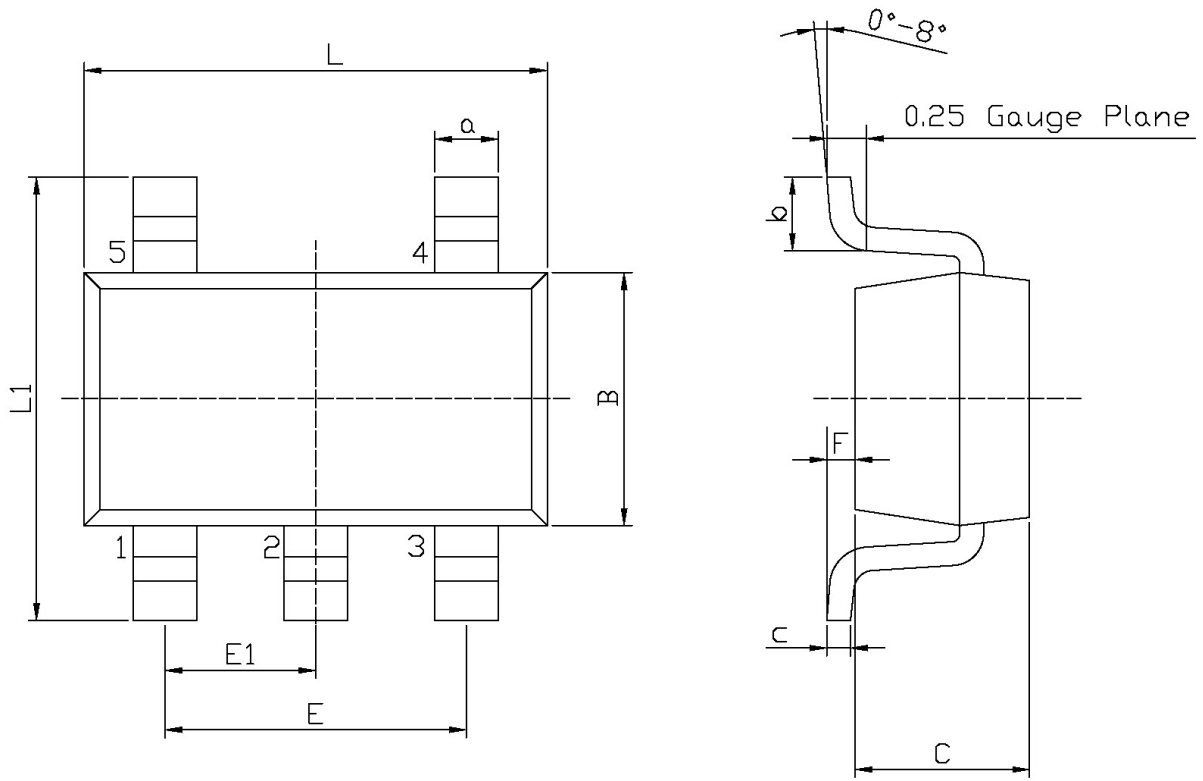

Unit: mm

Symbol	Dimensions In Millimeters		Symbol	Dimensions In Millimeters	
	Min	Max		Min	Max
L	2.82	3.02	E1	0.85	1.05
B	1.50	1.70	a	0.35	0.50
C	0.90	1.30	c	0.10	0.20
L1	2.60	3.00	b	0.35	0.55
E	1.80	2.00	F	0	0.15

SOT23-5

印章说明 / Marking Instructions

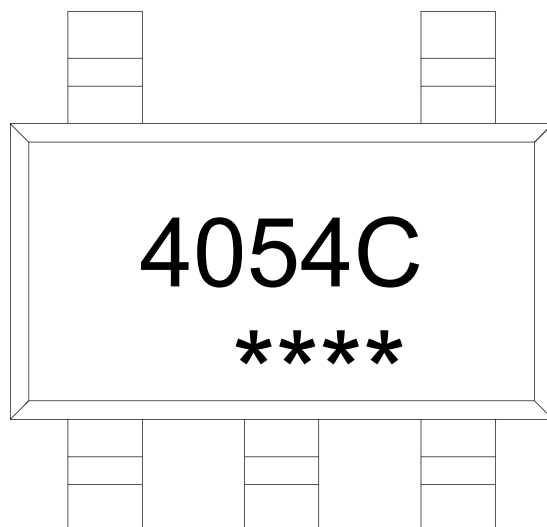

说明：

4054C： 为型号代码

****： 为生产批号代码，随生产批号变化

Note:

4054C: Product Type

****: Lot No. Code, code change with Lot No

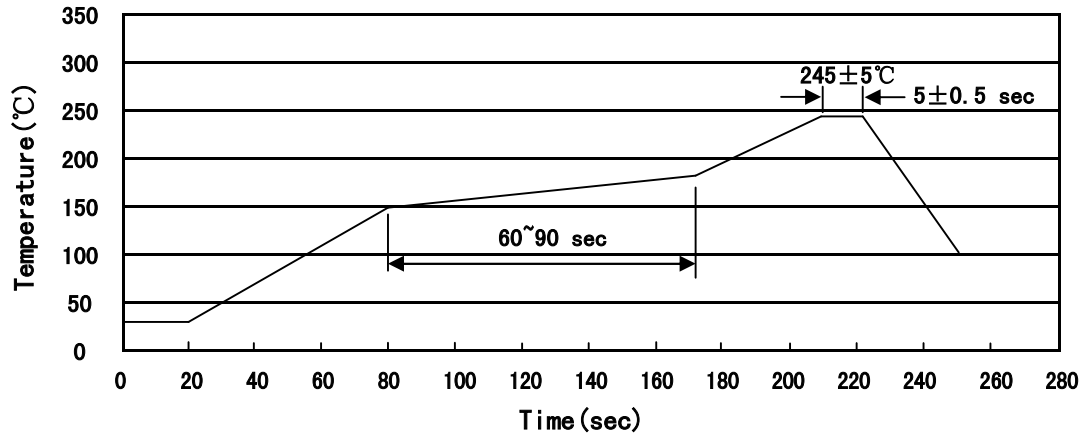
回流焊温度曲线图(无铅) / Temperature Profile for IR Reflow Soldering(Pb-Free)

说明：

- 1、预热温度 150~180°C，时间 60~90sec;
- 2、峰值温度 245±5°C，时间持续为 5±0.5sec;
- 3、焊接制程冷却速度为 2~10°C/sec.

Note:

- 1.Preheating:150~180°C, Time:60~90sec.
- 2.Peak Temp.:245±5°C, Duration:5±0.5sec.
3. Cooling Speed: 2~10°C/sec.

耐焊接热试验条件 / Resistance to Soldering Heat Test Conditions

温度：260±5°C

时间：10±1 sec.

Temp.:260±5°C

Time:10±1 sec

包装规格 / Packaging SPEC.

卷盘包装 / REEL

Package Type 封装形式	Units 包装数量					Dimension 包装尺寸 (unit: mm ³)		
	Units/Reel 只/卷盘	Reels/Inner Box 卷盘/盒	Units/Inner Box 只/盒	Inner Boxes/Outer Box 盒/箱	Units/Outer Box 只/箱	Reel	Inner Box 盒	Outer Box 箱
SOT23-5/6	3,000	10	30,000	4	120,000	7" ×8	210×205×205	445×230×435

使用说明 / Notices